



Cairngorms
National Park Authority

Ùghdarras Pàirc Nàiseanta a'
Mhonaidh Ruaidh

Item 5 Appendix 1c 26 January 2024

Agenda item 5

Appendix 1c

2023/0004/DET

Plans

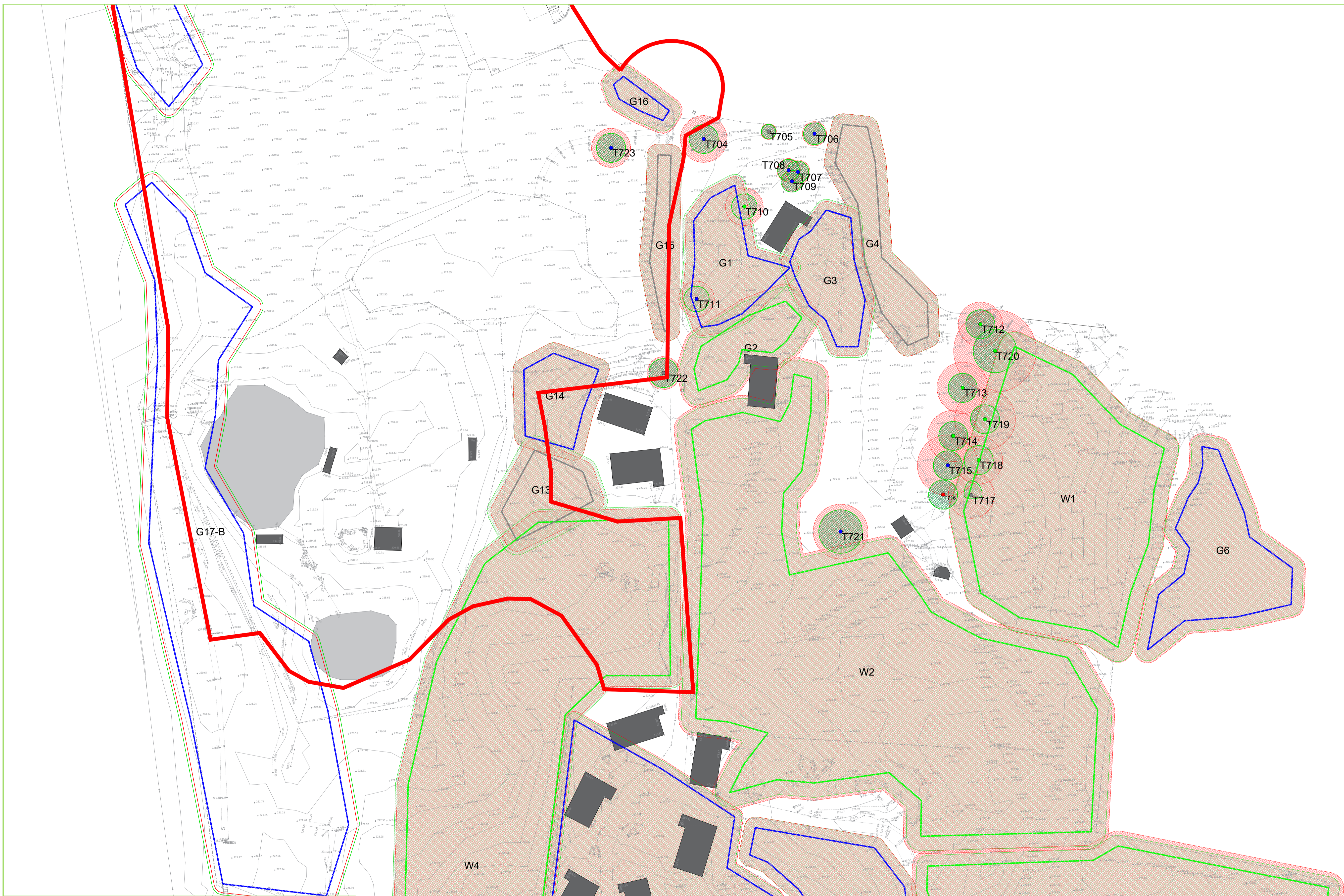

Tree Constraints Plan showing tree categories and root protection zones.

BS5837:2012 Tree Categories

- Category A**
Trees of high quality with an estimated remaining life expectancy of at least 40 years. Groups shown as hatched shapes.
- Category B**
Trees of moderate quality with an estimated remaining life expectancy of at least 20 years. Groups shown as hatched shapes.
- Category C**
Trees of low quality with an estimated remaining life expectancy of at least 10 years, or young trees with a stem diameter below 150 mm. Groups shown as hatched shapes.
- Category U**
Those in such a condition that they cannot realistically be retained as living trees in the context of the current land use for longer than 10 years. Groups shown as hatched shapes.
- BS 5837:2012 Root Protection Area**
- Tree Showing Canopy extents, category colour and tag number**

TREE CONSTRAINTS PLAN

1:500

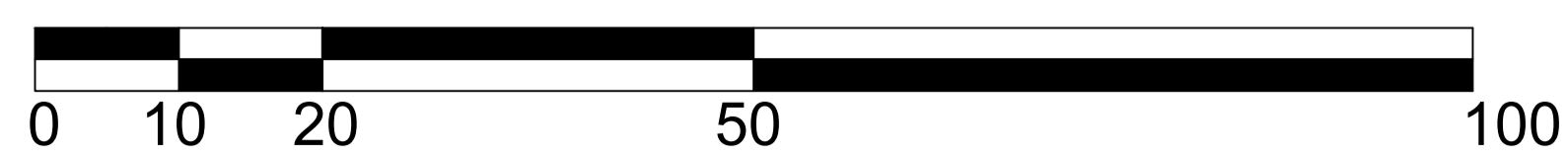

CLIENT Macdonald Resorts Ltd

TITLE Macdonald Resorts Tree Constraints Plan

JOB NO 0060

SCALE 1:500 @ A1

DRAWN JD

DATE 06 07 2022



Helge Hansen

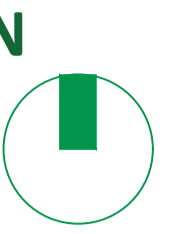

Master of Forestry Science
Email: helge@treemeister.co.uk
Mobile: 07568 165 146

- British Standard Tree Surveys
- Tree Condition Surveys
- Woodland Management
- Bat Surveys

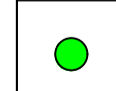
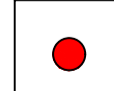
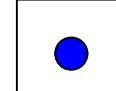

Tree Constraints Plan showing tree categories and root protection zones.

BS5837:2012 Tree Categories

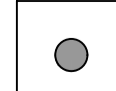
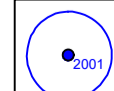
- | | | | |
|---|---|---|--|
|  | Category A
Trees of high quality with an estimated remaining life expectancy of at least 40 years. Groups shown as hatched shapes. |  | Category U
Those in such a condition that they cannot realistically be retained as living trees in the context of the current land use for longer than 10 years. Groups shown as hatched shapes. |
|  | Category B
Trees of moderate quality with an estimated remaining life expectancy of at least 20 years. Groups shown as hatched shapes. |  | BS 5837:2012 Root Protection Area |
|  | Category C
Trees of low quality with an estimated remaining life expectancy of at least 10 years, or young trees with a stem diameter below 150 mm. Groups shown as hatched shapes. |  | Tree
Showing Canopy extents, category colour and tag number |

TREE CONSTRAINTS PLAN

1:500

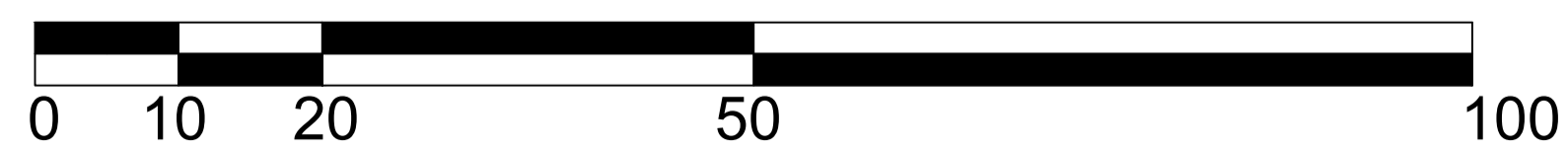

CLIENT Macdonald Resorts Ltd

TITLE Macdonald Resorts Tree Constraints Plan

JOB NO 0060

SCALE 1:500 @ A1

DRAWN JD

DATE 06 07 2022



Helge Hansen

Master of Forestry Science
Email: helge@treemeister.co.uk
Mobile: 07568 165 146

- British Standard Tree Surveys
- Tree Condition Surveys
- Woodland Management
- Bat Surveys

Group of semi mature birch.

Group of Norway

Group of semi mature birch, willow and poplar.

Group of semi mature birch.

Group of semi mature birch.

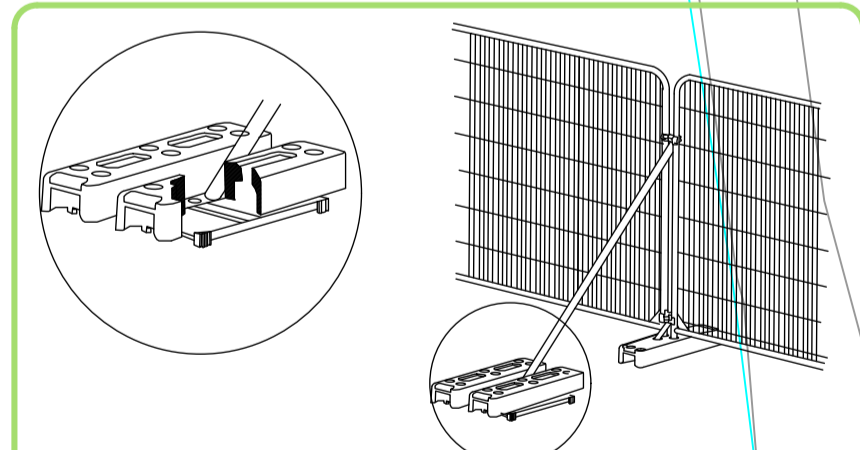
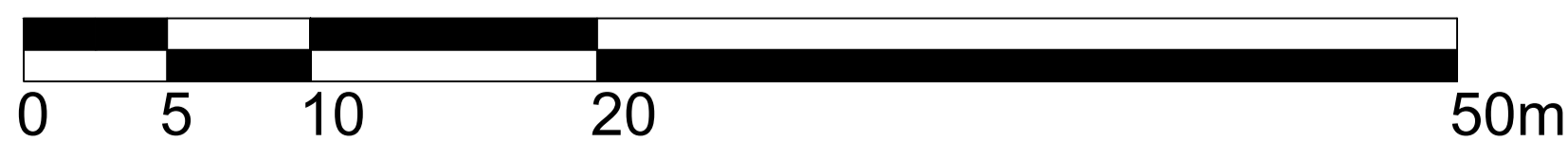

ILLUSTRATION SHOWING HERAS FENCING AS TEMPORARY GROUND/ROOT PROTECTION BARRIER WITH STABILIZER MOUNTED ON BLOCK TRAY ON ROOT SIDE AS RECOMMENDED BY BS 5837:2012 SEE PLAN FOR POSITIONING

Tree Protection Plan showing tree categories and root protection zones.
BS5837:2012 Tree Categories

	Root Protection Area		Category C Trees of low quality with an estimated remaining life expectancy of at least 10 years, or young trees with a stem diameter below 150 mm. Groups shown as hatched shapes.		Tree protection Fencing
	Category A: Tree of high quality with a remaining life expectancy of at least 40 years.		Category U: Those in such a condition that they cannot realistically be retained as living trees in the context of the current land use for longer than 10 years. Groups shown as hatched shapes.		Geoweb Root Protection
	Category B: Trees of moderate quality with an estimated remaining life expectancy of at least 20 years. Groups shown as hatched shapes.		Tree for Removal		

TREE Protection PLAN
1:250



SCALE BAR 1:250



CLIENT	Macdonald Hotels, C/O Mabbett and Associates Ltd	
	Willow House	
	Stoneyfield Business Park, IV2 7PA	
TITLE	Tree Protection Plan_revC	
JOB NO	0061	SCALE 1:250 @ A1
DRAWN	HH	DATE 18.10.2023



Helge Hansen
Master of Forestry Science
Email: helge@treemeister.co.uk
Mobile: 07568 165 146

- British Standard Tree Surveys
- Tree Condition Surveys
- Woodland Management
- Bat Surveys



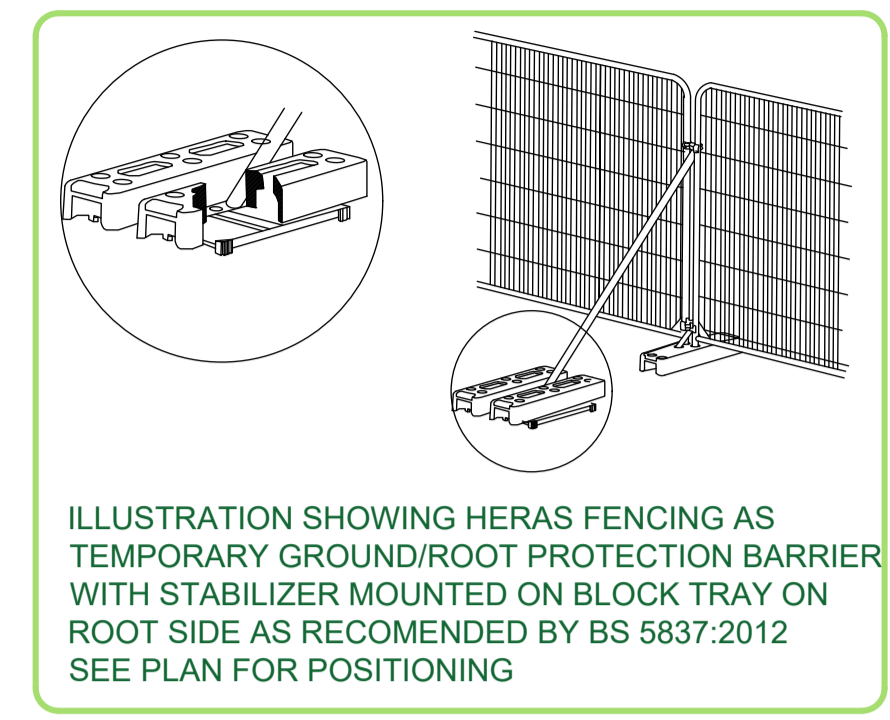

Group of semi mature birch.

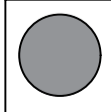

Group of semi mature birch.

Group of Norway spruce with some sycamore.

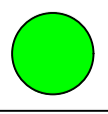
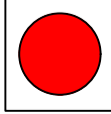
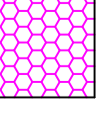
Tree Protection Plan showing tree categories and root protection zones.
BS5837:2012 Tree Categories

 Root Protection Area	 Category C Trees of low quality with an estimated remaining life expectancy of at least 10 years, or young trees with a stem diameter below 150 mm. Groups shown as hatched shapes.	 Tree protection Fencing
 Category A: Tree of high quality with a remaining life expectancy of at least 40 years.	 Category U Those in such a condition that they cannot realistically be retained as living trees in the context of the current land use for longer than 10 years. Groups shown as hatched shapes.	 Geoweb Root Protection
 Category B: Trees of moderate quality with an estimated remaining life expectancy of at least 20 years. Groups shown as hatched shapes.	 Tree for Removal	

TREE PROTECTION PLAN
1:250

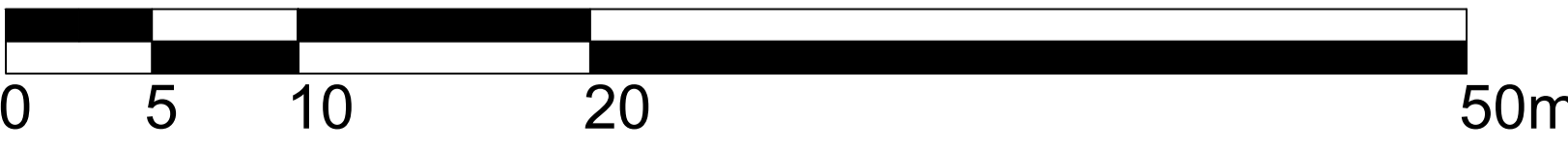

SCALE BAR 1:250



CLIENT	Macdonald Hotels, C/O Mabbett and Associates Ltd	
	Willow House	
	Stoneyfield Business Park, IV2 7PA	
TITLE	Tree Protection Plan_revC	
JOB NO	0061	SCALE 1:250 @ A1
DRAWN	HH	DATE 18.10.2023



Helge Hansen
Master of Forestry Science
Email: helge@treemeister.co.uk
Mobile: 07568 165 146

- British Standard Tree Surveys
- Tree Condition Surveys
- Woodland Management
- Bat Surveys

Group of semi mature birch.

Group of semi mature birch.

Group of semi mature birch.

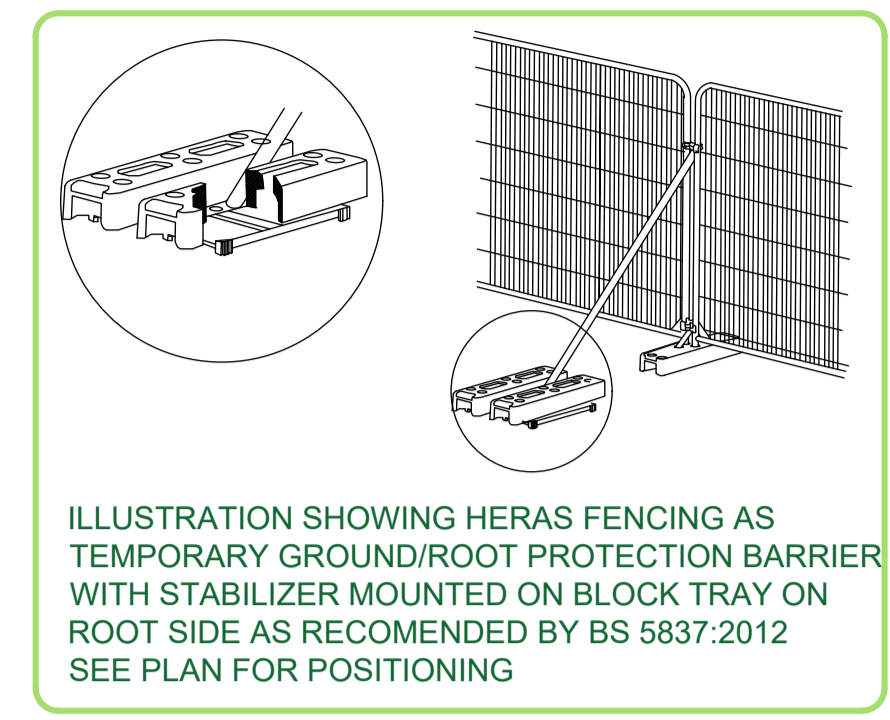

ILLUSTRATION SHOWING HERAS FENCING AS TEMPORARY GROUND/ROOT PROTECTION BARRIER WITH STABILIZER MOUNTED ON BLOCK TRAY ON ROOT SIDE AS RECOMMENDED BY BS 5837:2012 SEE PLAN FOR POSITIONING



Tree Protection Plan showing tree categories and root protection zones.
BS5837:2012 Tree Categories

	Root Protection Area		Category C Trees of low quality with an estimated remaining life expectancy of at least 10 years, or young trees with a stem diameter below 150 mm. Groups shown as hatched shapes.		Tree protection Fencing
	Category A: Tree of high quality with a remaining life expectancy of at least 40 years.		Category U: Those in such a condition that they cannot realistically be retained as living trees in the context of the current land use for longer than 10 years. Groups shown as hatched shapes.		Geoweb Root Protection
	Category B: Trees of moderate quality with an estimated remaining life expectancy of at least 20 years. Groups shown as hatched shapes.		Tree for Removal		

TREE PROTECTION PLAN
1:250

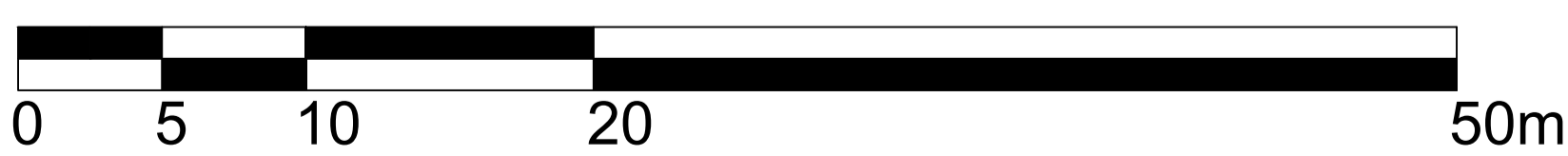

SCALE BAR 1:250



CLIENT	Macdonald Hotels, C/O Mabbett and Associates Ltd	
	Willow House	
	Stoneyfield Business Park, IV2 7PA	
TITLE	Tree Protection Plan_revC	
JOB NO	0061	SCALE 1:250 @ A1
DRAWN	HH	DATE 18.10.2023

Helge Hansen
Master of Forestry Science
Email: helge@treemeister.co.uk
Mobile: 07568 165 146

- British Standard Tree Surveys
- Tree Condition Surveys
- Woodland Management
- Bat Surveys